



TECHNICAL SPECIFICATIONS

CS 8200 3D Access

CS 8200 3D Neo Edition

X-RAY GENERATOR

Tube voltage	60-90 kV	60-90 kV
Tube current	2-15 mA	2-15 mA
Frequency	140 kHz	140 kHz
Minimum required space	1200 (L) x 1400 (D) x 2400 (H) mm + ceph arm: 2000 (L) x 1400 (D) x 2400 (H) mm	1200 (L) x 1400 (D) x 2400 (H) mm + ceph arm: 2000 (L) x 1400 (D) x 2400 (H) mm
Weight	Without ceph arm: 92 kg (202 lb.) With ceph arm: 125kg (276 lb.)	Without ceph arm: 92 kg (202 lb.) With ceph arm: 125kg (276 lb.)

3D MODALITY

Field Of View diameter x height (cm)	4 x 4 - 5 x 5 - 5 x 8 - 8 x 5 - 8 x 9 ¹ 10 x 5 ¹ - 10 x 10 ¹	4 x 4 - 5 x 5 - 5 x 8 - 8 x 5 - 8 x 9 ¹ 10 x 5 ¹ - 10 x 10 ¹ - 12 x 5 ¹ - 12 x 10 ¹
Voxel size (µm)	75 µm minimum	75 µm minimum
Exposure time	6s to 15s	3s to 20s

PANORAMIC MODALITY

Magnification	1.2	1.2
Radiological exam options	Full panoramic, segmented panoramic (including bitewing segmented panoramic), maxillary sinus, LA TMJ x 2, LA TMJ x 4	Full panoramic, segmented panoramic (including bitewing segmented panoramic), maxillary sinus, LA TMJ x 2, LA TMJ x 4
Exposure time	2 to 14 seconds	2 to 14 seconds

CEPHALOMETRIC MODALITY

Magnification	1.13	1.13
Radiological exams	Lateral, frontal AP or PA, oblique, submento-vertex, carpus (optional)	Lateral, frontal AP or PA, oblique, submento-vertex, carpus (optional)
Exposure time	2.9 to 11 seconds	2.9 to 11 seconds

¹ Option. In Ontario (Canada), the use by dentists of FOVs over 8 x 8 cm is subject to conditions

CS 8200 3D NEO EDITION WITHOUT CEPHALOMETRIC ARM

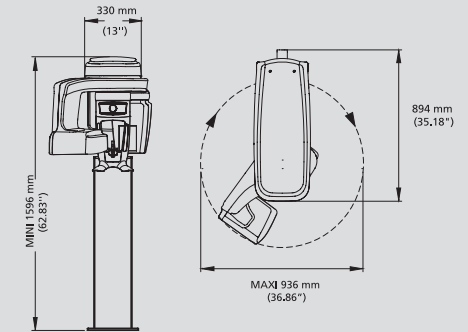

CS 8200 3D NEO EDITION WITH CEPHALOMETRIC ARM

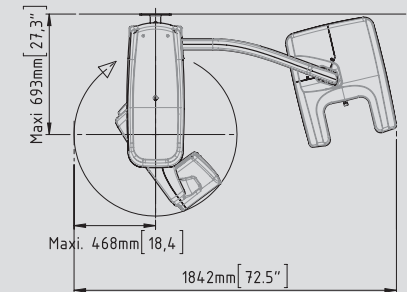
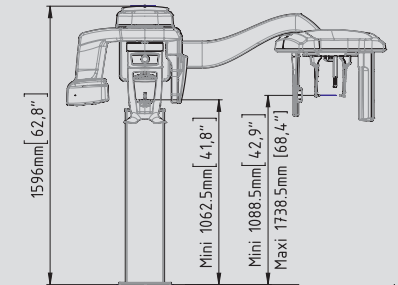

Learn more about the new CS 8200 3D Family
by visiting [carestreamdental.com](https://www.carestreamdental.com)



Envision your future practice

Take your practice further with the
CS 8200 3D Family of CBCT systems



CS 8200 3D Access



CS 8200 3D Neo Edition



What's the vision for your practice?

As a general practitioner you'll know the importance of having a vision for the growth of your practice. Being able to diagnose more confidently, boost patient care and improve workflow are all goals that you need to deliver on.

With Carestream Dental's new CS 8200 3D Family of CBCT imaging systems, you'll be able to achieve these goals and more with a system tailored to the needs of your practice – both now and in the future.



See more and do more with **CBCT imaging**

CBCT technology and 3D imaging reveals a new dimension within dental diagnostics and treatment planning – especially in disciplines such as endodontics, implant planning and oral surgery. But this impressive imaging technology changes the game for general dentists and practitioners too.

It will enable you to diagnose more confidently, work faster and highlight better treatment options for your patients.



See the possibilities...

Carestream Dental's new CS 8200 3D Family of CBCT imaging systems enables new possibilities for your dental practice.

Choose between the **new CS 8200 3D Access** and the **CS 8200 3D Neo Edition**.

Both systems deliver state-of-the-art imaging that matches the needs of your dental practice – whatever the size. Once installed, you'll benefit from advanced technology that can take your practice further.





More confident diagnosis

Be more confident in your diagnosis and discover better treatment options. Our family of CBCT systems will help you diagnose and plan before treatment so that you can, for instance, understand the canal morphology or avoid complications during surgery.



Enhanced patient care

3D images are easy for you to read and for your patients to understand. Reviewing these realistic 3D images together can help to engage your patient and boost their acceptance of the treatment plan.



Expand your dental practice

Use your CBCT system to perform more in-office procedures and extend the capabilities of your practice. Avoid lengthy treatment processes for your patients, where they may have to be referred to specialists outside your practice.



Earn back your investment

A CBCT system will not only help you make faster, more informed decisions, but each time it is used, it will help your business earn back on the original investment by generating additional revenue from 2D and 3D examinations.





Meet the future

With Carestream Dental's state-of-the-art CBCT imaging systems outstanding 2D and 3D images reveal the treatment your patients need and help provide them with the smiles they deserve.



Systems at a glance



CS 8200 3D Neo Edition

- Optimize workflow and futureproof your practice
- Extended fields of view
- Scout view



CS 8200 3D Access

- Bring advanced CBCT imaging within reach
- Easy to use
- Great value



4-in-1 versatility

A 4-in-1 solution that blends panoramic technology, CBCT imaging, 3D model scanning and optional cephalometric imaging.



Low dose 2D and 3D imaging

Each of our systems allow users to collimate the imaging area to limit radiation exposure according to the ALADA principle. The low-dose mode delivers high-quality 3D images at the same or a lower dose as standard panoramic examinations.²



75-micron precision

75-micron CBCT resolution lets you visualize the tiniest clinical details and is perfectly suited for endodontic indications.

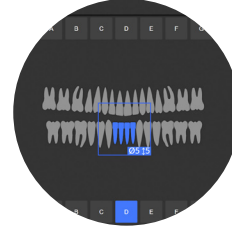

See the simplicity

All systems in the family are intuitive, with a modern, user-friendly interface that is easy to navigate. The interface is furthermore designed to facilitate exam set up, with the settings all on the same screen for faster workflow.

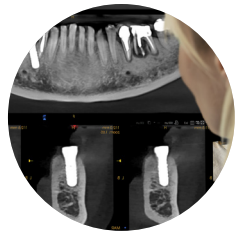

Artifact-free images

Game-changing CS MAR¹ technology with live comparison automatically reduces metal artifacts to help confirm diagnosis and reduce the risk of misinterpretation.



Open for easy integration

Built on an open platform, Carestream Dental's CBCT systems help oral healthcare professionals to work with their preferred partners and labs. Furthermore, easy integration means quick, seamless workflow.

¹ Option

² Based on studies conducted by John Ludlow, University of North Carolina, School of Dentistry, utilizing the CS 8100 3D dose protocol (Aug 2014, Nov 2015, May 2017).

CS 8200 3D Neo Edition

Envision your practice **without compromise**

With Carestream Dental's CS 8200 3D Neo Edition, your patients will benefit from our most advanced system within the CS 8200 3D Family. Envision more confidence in your diagnosis, optimal treatment and planning, ease of use, and easy integration. Discover your future practice with a range of advanced CBCT imaging features.



The broadest range of fields of view in its category

The CS 8200 3D Neo Edition features extended fields of view, perfectly suited for scanning the full arch including third molars. The system allows you to select between up to nine different fields of view for more versatility and more advanced clinical needs.



Full control of the imaging area

The low dose scout imaging makes it easy for you to control the imaging area prior to the examination and reduces the risk of retakes.

Up to nine different fields of view

Select between nine fields of view, ranging from 4 cm x 4 cm to 12 cm x 10 cm, which cover virtually all the diagnostic needs of dental and speciality practices.

Single-touch repeatability

Parameters are recorded for each patient, making follow-up exams repeatable with a single touch. This streamlines your workflow and delivers comparable images over time.

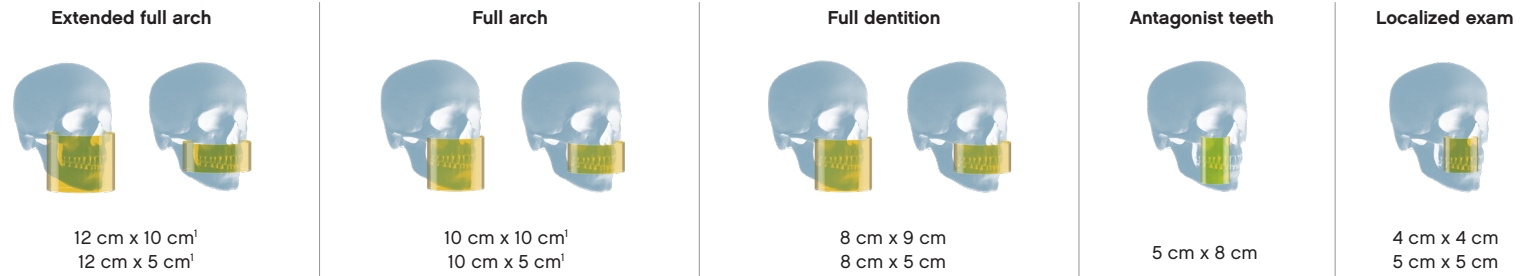

¹10 cm x 5 cm, 10 cm x 10 cm, 12 cm x 5 cm and 12 cm x 10 cm are options. In Ontario (Canada), the use by dentists of FOVs over 8 x 8 cm is subject to conditions.

CS 8200 3D_{Access}

Access your future practice

Start your CBCT journey with advanced 2D and 3D imaging now within reach. Get access to more confident diagnosis, improved patient care, and the possibility of growing your business through enabling more in-office procedures.

Enjoy CBCT imaging that's easier than you think and built on an open platform so that you can activate your future practice here and now.

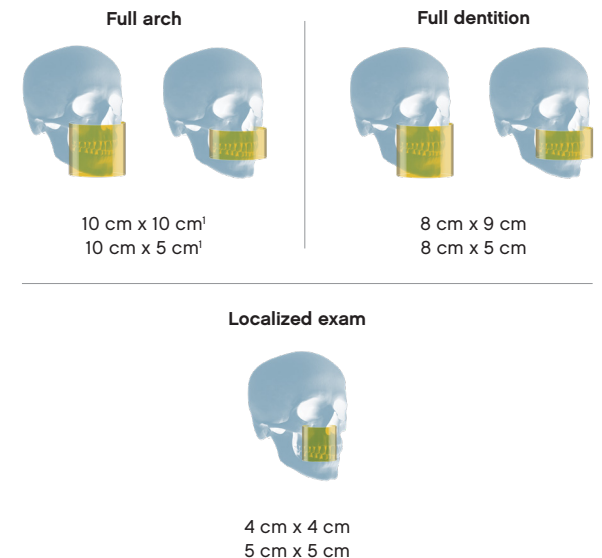

¹ 10 cm x 5 cm, 10 cm x 10 cm are options. In Ontario (Canada), the use by dentists of FOVs over 8 x 8 cm is subject to conditions.



State of the art and easy to use

The CS 8200 3D Access is your best way into the world of 3D imaging, with state-of-the-art technology that provides outstanding 2D and 3D images but is surprisingly easy to use.



Intuitive hardware and interface

The CS 8200 3D Access has a modern, intuitive interface and simple hardware that makes it easier to capture new scans for quicker, more streamlined workflow.



Great value

If you ever thought CBCT imaging is financially out of reach, you're not alone. However, the new CS 8200 3D Access makes advanced imaging technology accessible and enables more in-office procedures that pay you back in the long term.

Capture the power of cephalometric images

Featuring ultra-fast scanning technology and automatic tracing software, our state-of-the-art Scan Ceph module is designed to cover all of your orthodontic needs and save time. Whatever the examination, you can be sure of consistent, high-quality images at the lowest dose, and fast, precise analysis.

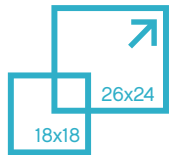

Flexible image options

Features all common projections and multiple image formats (26 cm x 24 cm to 18 cm x 18 cm).



Fast scan times

Our cephalometric imaging systems deliver outstanding images in as little as 3 seconds.

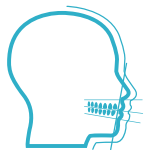

Automatic tracing

Allows full tracings of images in just 10 seconds – saving you time and improving patient care.



Embrace the possibilities of CBCT

CBCT imaging can be used for a variety of everyday clinical tasks including endodontics, third-molar removal, pre-surgical planning and more.

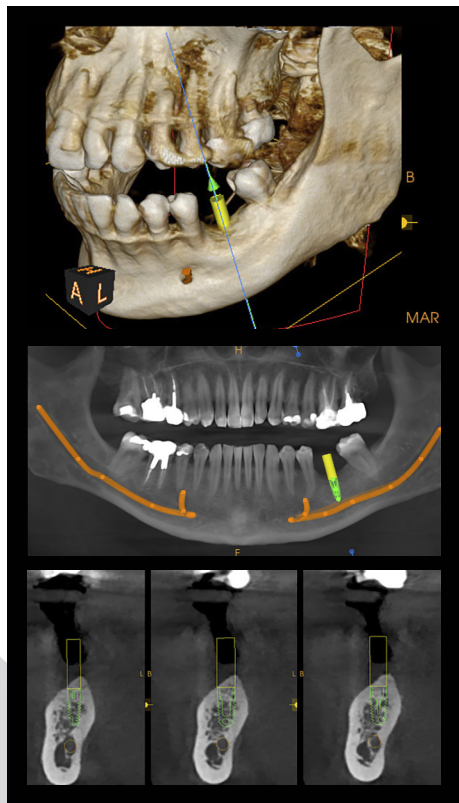

Implants

Evaluate bone quantity and quality and localize anatomical obstacles.

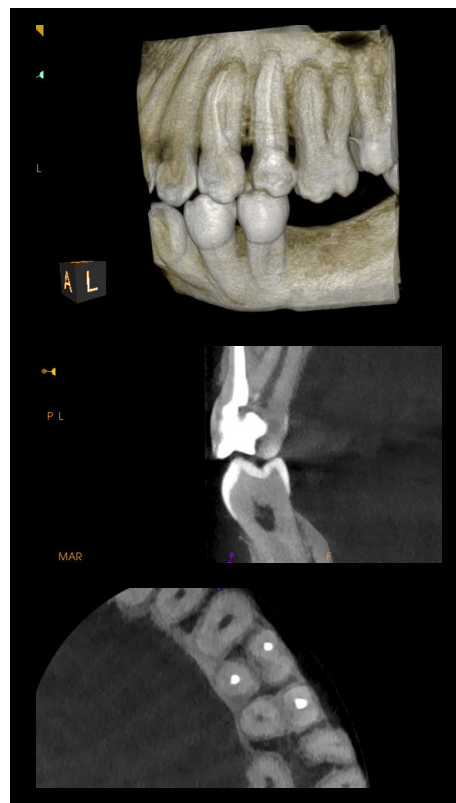

Endodontics

Assess tooth and root canal morphology precisely, diagnose fractures and periapical lesions.

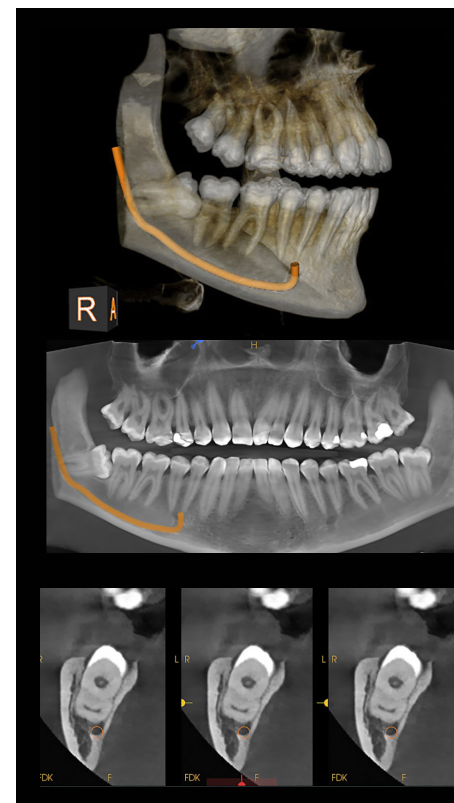

Oral surgery

Visualize impacted teeth or cysts and define surgical protocol for removal.



Orthodontics

Evaluate impacted teeth and follow up orthodontic treatment.

Imaging software that enables your future practice

Experience software that helps you get the most from your images. Our portfolio of innovative imaging software and optional add-on modules, enable you to expand the capabilities of your practice on your own terms.



CS Imaging

Discover a new generation of dental imaging software with CS Imaging version 8. This powerful platform provides easy one-stop access to all your 2D images, 3D images and CAD/CAM data, so you can manage your digital workflow more effectively.



CS 3D Imaging

This user-friendly program is designed to enhance patient communication and improve diagnostic and treatment planning capabilities in implant planning, endodontics, oral surgery and orthodontics.

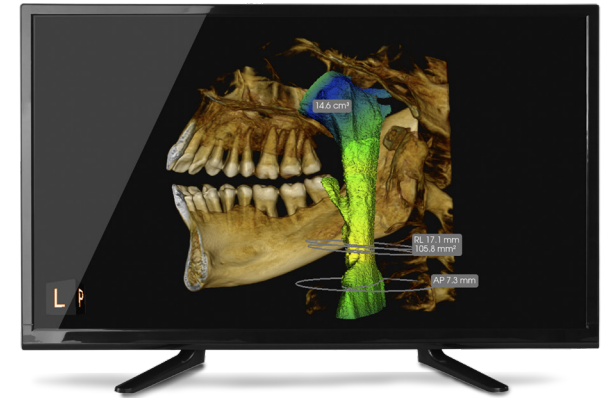

Optional modules

Prosthetic-driven implant planning

A user-friendly and open software to plan implants with higher predictability.

CS Airway

Simplifies airway analysis through color-coded views and automatic measurements.

CS 3D Imaging now powered by AI

Discover two new AI-powered features saving you time and ensuring precise results. **Automatic Panoramic Curve Mapping** automatically maps the panoramic curve on the CBCT scan. Furthermore, **Automatic Nerve Mapping** automatically detects and traces mandibular canals on the CBCT scan.



CS 3D Imaging now powered by AI

New AI-powered features make our CS 3D Imaging software easier to use and enable more effective workflow by automating tasks. Meaning you save valuable time and ensure precise results.



Open integration with intraoral scanners.

The CS 8200 3D Family is built on an open platform meaning you can easily connect CS Imaging software with leading intraoral scanners for fast, seamless workflow.



Optimize service and support for your practice

Turn your Carestream Dental CS 8200 3D Neo Edition into a connected device with CS UpStream¹. CS UpStream gathers and analyzes data and notifies your practice should any action be required.